

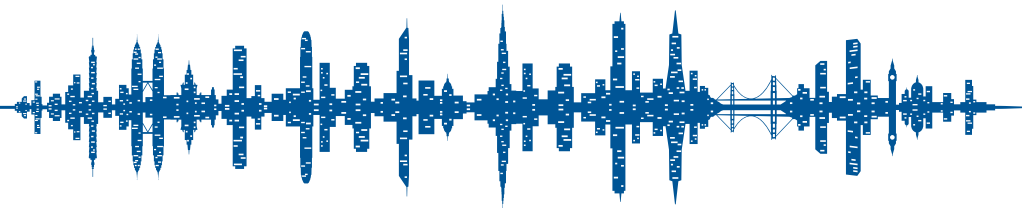

plantronics®

Electronic Hook Switch Guide



SAVI® 700 SERIES | CS500™ SERIES | MDA200™

Electronic Hook Switch Guide Contents

Electronic Hook Switch Cables (EHS) provide remote desk phone call control (answer/end) with your Plantronics wireless headset system (or the MDA200™ headset hub). We offer cables that are compatible with many of the most popular office desk phones.

We also have a handset lifter accessory that can be used with most desk phones that are not compatible with one of our EHS cables.

Visit Plantronics.com for more information.



1
Aastra Phone Models



6
Polycom Phone Models



2
Alcatel-Lucent Phone Models



7
ShoreTel Phone Models



3
Avaya Phone Models



8
Siemens Phone Models



4
Cisco Phone Models



9
Tenovis Phone Models



5
Nortel Phone Models



10
Toshiba Phone Models

Electronic Hook Switch for Aastra®

AASTRA

Desk Phone Models

- 6739i
- 6753i
- 6755i
- 6757i
- 6757i CT
- Aastra 6771
- Aastra 6773
- Aastra 6775
- Aastra 6773 IP
- Aastra 6775 IP
- Aastra 5370
- Aastra 5380
- Aastra 5370 IP
- Aastra 5380 IP



EHS Cable

APS-11*
PN: 37818-11



* APS-11 replaces APS-10

Plantronics Audio Solutions



Savi® 700 Series
Wireless headset system manages PC, mobile and desk phone calls



CS500™ Series
Wireless headsets manage desk phone calls



MDA200™
Enables USB connectivity to the desk phone to manage both PC and desk phone calls

EHS Setup Use the EHS setup below to automatically answer a desk phone call by pressing a button on your Savi 700 Series or CS500 Series headset or MDA200.

Aastra models: 6771, 6113, 6775, 6773 IP, 6775 IP, 5370, 5380, 5370 IP, 5380 IP, 6753i, 6739i, 6755i, 6757i, 6757i CT

Setup

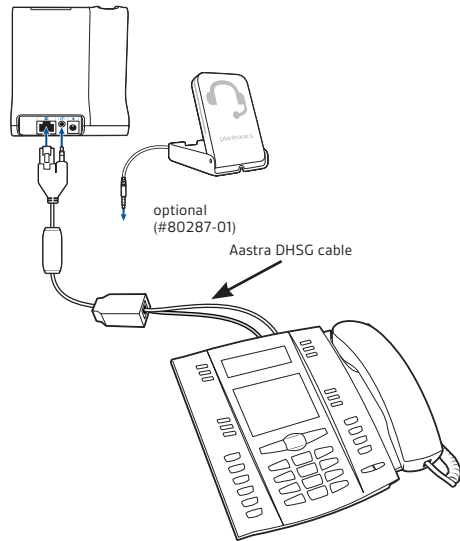

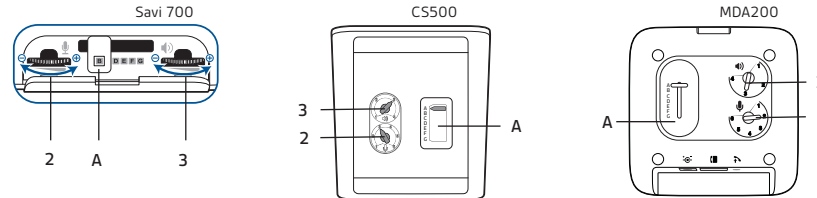

Configuration



Only the Aastra DHSG cable should be connected directly to your phone.
No 3rd party DHSG cables should be connected directly to the Aastra IP phone.

Electronic Hook Switch for Alcatel-Lucent

Alcatel-Lucent 



Desk Phone Models
 IP Touch 4028, IP Touch 4038, IP Touch 4068, Touch 4029, Touch 4039, My IC 8082

EHS Cable



APA-23*
 PN: 38908-11

* APA-23 replaces APA-20 and APA-22

Plantronics Audio Solutions



Savi 700 Series
 Wireless headset system manages PC, mobile and desk phone calls



CS500 Series
 Wireless headsets manage desk phone calls



MDA200
 Enables USB connectivity to the desk phone to manage both PC and desk phone calls

EHS Setup Use the EHS setup below to automatically answer a desk phone call by pressing a button on your Savi 700 Series or CS500 Series headset or MDA200.

Alcatel-Lucent models: IP Touch 4028, 4038, 4068

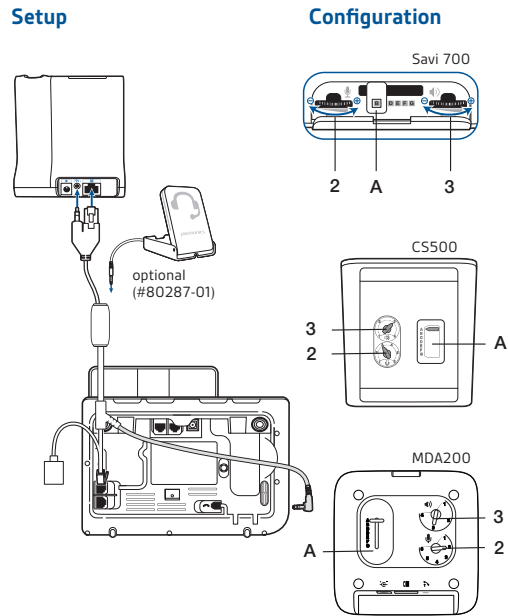

Alcatel-Lucent models: Touch 4029, 4039

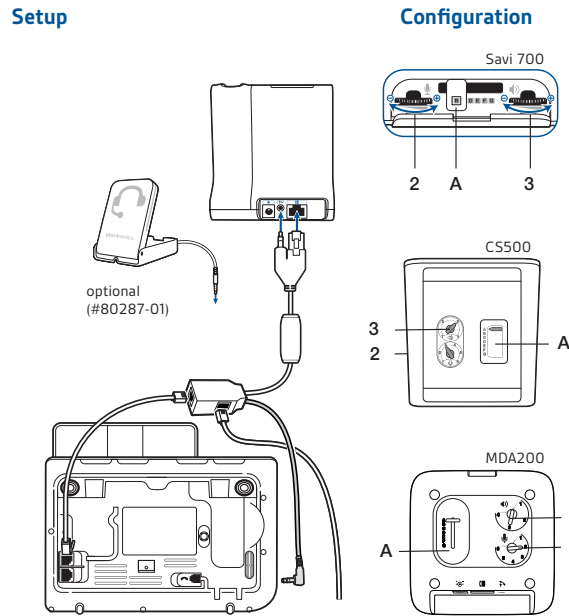

Alcatel-Lucent models: My IC 8082

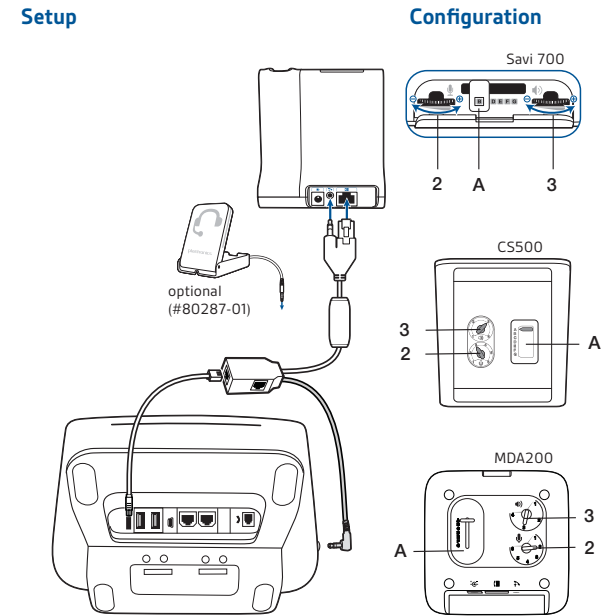

Electronic Hook Switch for Avaya®

AVAYA

APV-63 Cable

1408	9608	9670
1416	9611	9620L
1608	9620	2410
1616	9621	4630
9404	9630	6416D+M
9406	9640	6424D+M
9504	9641G	
9508	9650	

APV-66 Cable

2420	4621SW	5420
4610	4622SW	5610
4610SW	4625SW	5620
4620	4630SW	5621
4620SW		



+

EHS Cable

APV-63*
PN: 38734-11



APV-66*
PN: 38633-11



* APV-63 replaces APV-62; APV-66 replaces APV-65

+

Plantronics Audio Solutions



Savi 700 Series
Wireless headset system manages PC, mobile and desk phone calls



CS500 Series
Wireless headsets manage desk phone calls



MDA200
Enables USB connectivity to the desk phone to manage both PC and desk phone calls

EHS Setup Use the EHS setup below to automatically answer a desk phone call by pressing a button on your Savi 700 Series or CS500 Series headset or MDA200.

Avaya models: 1408, 1416, 1608, 1616, 9404, 9406, 9504, 9508, 9608, 9611, 9620, 9621, 9630, 9640, 9641G, 9650, 9670, 9620L

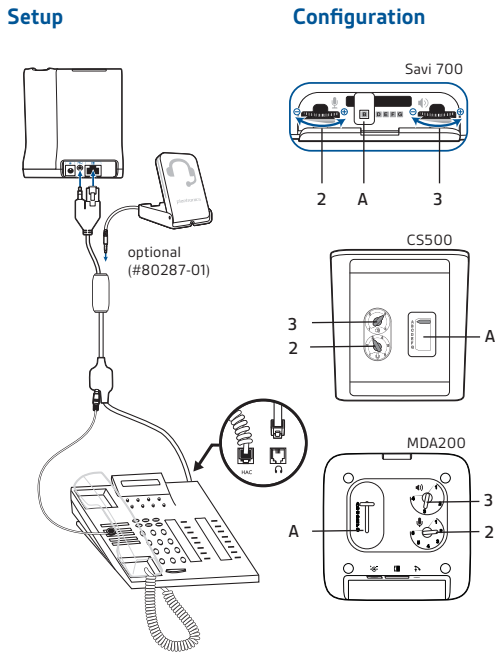

Avaya models: 2410, 4630, 6416D+M, 6424D+M

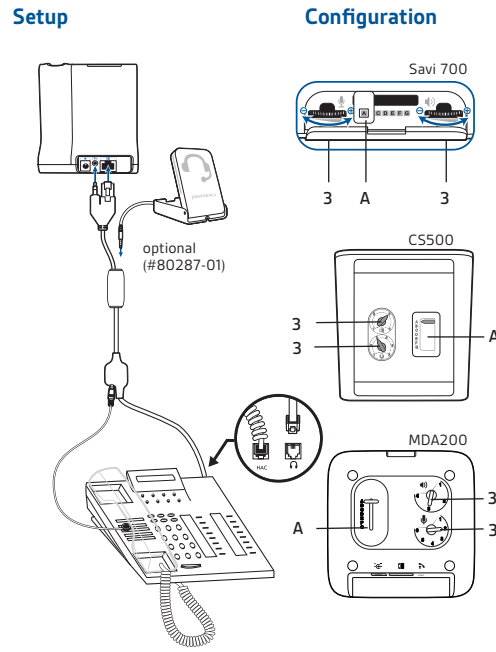

Avaya models: 2420, 4610, 4610SW, 4620, 4620SW, 4621SW, 4622SW, 4625SW, 4630SW, 5420, 5610, 5620, 5621

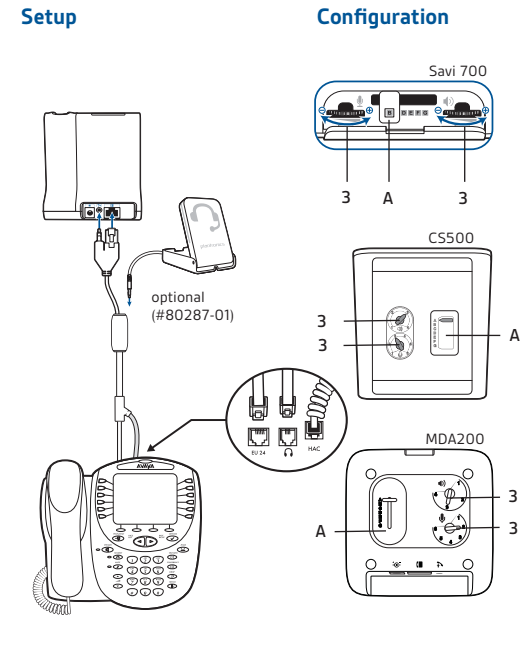

Electronic Hook Switch for Cisco®



APC-41 Cable
7942G
7945G
7962G
7965G
7975G

APU-71 Cable
8961
9951
9971

EHS Cable

APC-41*
PN: 38350-11

APU-71*
PN: 83018-11

* APC-41 replaces APC-40; APU-71 has replaced APT-70



Plantronics Audio Solutions



Savi 700 Series
Wireless headset system manages PC, mobile and desk phone calls

CS500 Series
Wireless headsets manage desk phone calls

MDA200
Enables USB connectivity to the desk phone to manage both PC and desk phone calls

EHS Setup Use the EHS setup below to automatically answer a desk phone call by pressing a button on your Savi 700 Series or CS500 Series headset or MDA200.

Cisco models: 7942G, 7945G, 7962G, 7965G, 7975G

Setup

Configuration

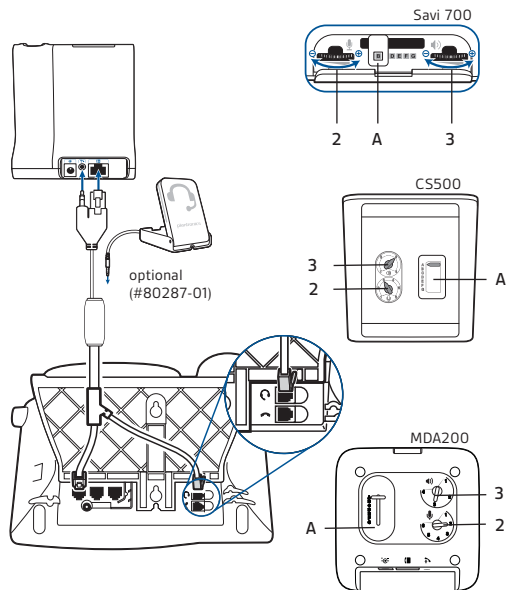

Cisco models: 7942G, 7945G, 7962G, 7965G, 7975G

Setup

Configuration

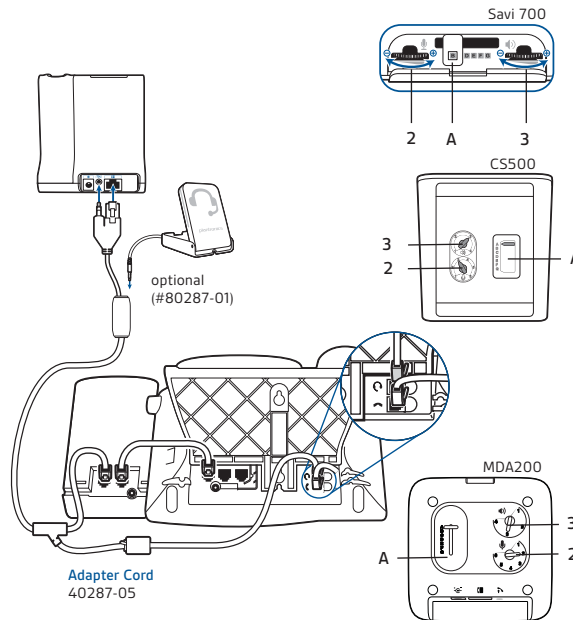

Cisco models: 8961, 9951, 9971

Setup

Configuration

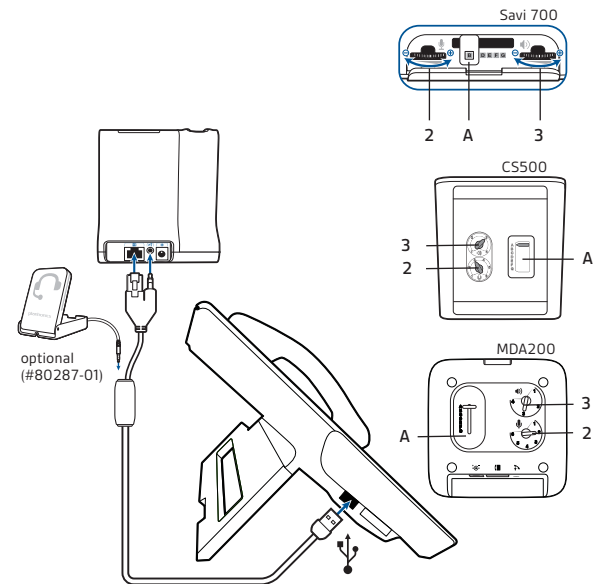

Electronic Hook Switch for Cisco®



+

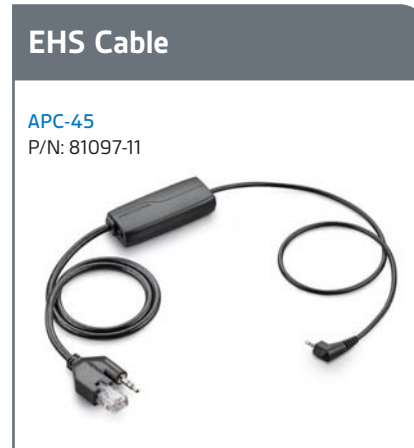

+



EHS Setup Use the EHS setup below to automatically answer a desk phone call by pressing a button on your Savi 700 Series or CS500 Series headset or MDA200.

Cisco models: SPA512, SPA514, SPA525G2

Setup

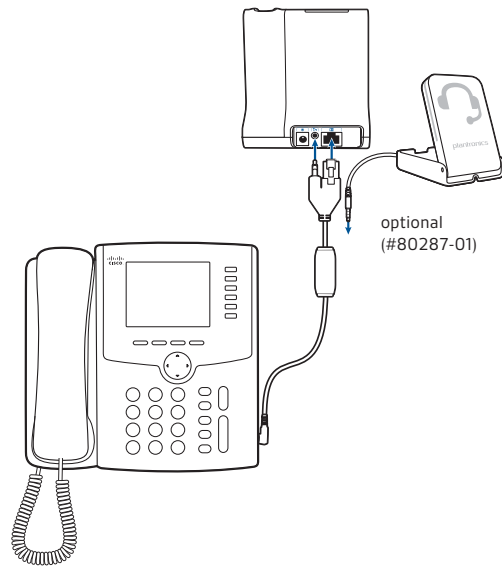

Configuration

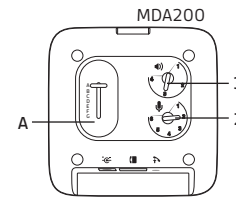
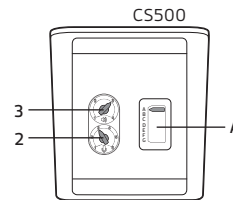
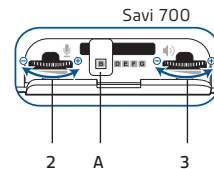

Electronic Hook Switch for Nortel®

NORTEL



Desk Phone Models
 1120E 1150E
 1140E 1165E

+

EHS Cable



APU-71*
 PN: 83018-11

* APU-71 replaces APT-70

+

Plantronics Audio Solutions



Savi 700 Series
 Wireless headset system manages PC, mobile and desk phone calls

CS500 Series
 Wireless headsets manage desk phone calls

MDA200
 Enables USB connectivity to the desk phone to manage both PC and desk phone calls

EHS Setup Use the EHS setup below to automatically answer a desk phone call by pressing a button on your Savi 700 Series or CS500 Series headset or MDA200.

Nortel models: 1120E, 1140E, 1150E, 1165E

Setup

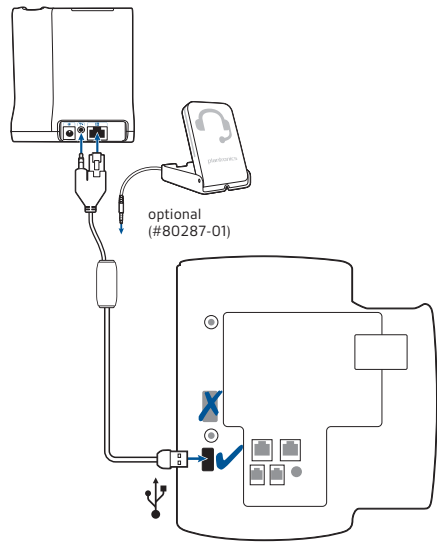

Configuration

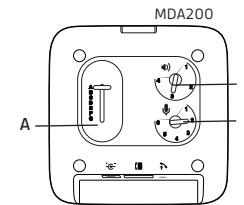
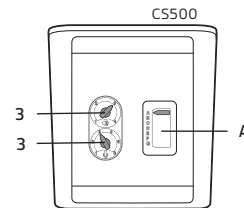
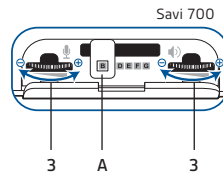

Electronic Hook Switch for Polycom®

POLYCOM®

Desk Phone Models

- SoundPoint® IP 320
- SoundPoint IP 321
- SoundPoint IP 330
- SoundPoint IP 331
- SoundPoint IP 335
- SoundPoint IP 430
- SoundPoint IP 450
- SoundPoint IP 550
- SoundPoint IP 560
- SoundPoint IP 650
- SoundPoint IP 670
- VVX500
- VVX1500



+

EHS Cable



APP-51*
PN: 38439-11

* APP-51 replaces APU-50

+

Plantronics Audio Solutions



Savi 700 Series
Wireless headset system manages PC, mobile and desk phone calls

CS500 Series
Wireless headsets manage desk phone calls

MDA200
Enables USB connectivity to the desk phone to manage both PC and desk phone calls

EHS Setup Use the EHS setup below to automatically answer a desk phone call by pressing a button on your Savi 700 Series or CS500 Series headset or MDA200.

Polycom models: SoundPoint IP 320, 321, 330, 331, 335, 430, 450, 550, 560, 650, 670, VVX500, VVX1500

Setup

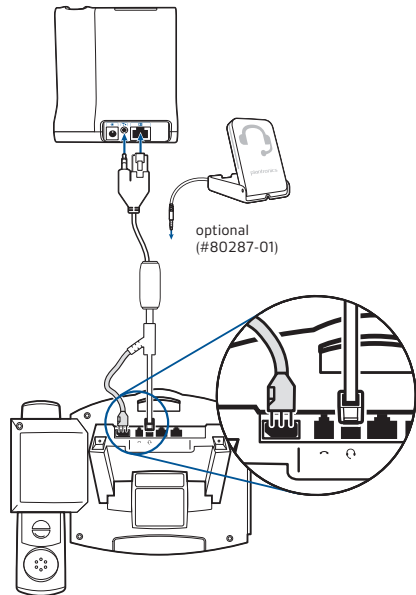

Configuration

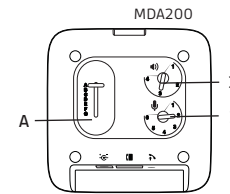
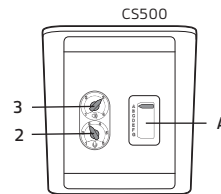
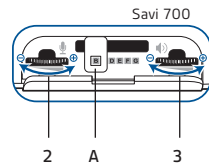

Electronic Hook Switch for ShoreTel®



ShoreTel®
Pure IP Unified Communications Solutions

Desk Phone Models
IP212K IP265 IP560 (g)
IP230 IP560 IP565 (g)
IP655

+

EHS Cable



RD-1
PN: 78887-01

+

Plantronics Audio Solutions



Savi 700 Series
Wireless headset system manages PC, mobile and desk phone calls

CS500 Series
Wireless headsets manage desk phone calls

MDA200
Enables USB connectivity to the desk phone to manage both PC and desk phone calls

EHS Setup Use the EHS setup below to automatically answer a desk phone call by pressing a button on your Savi 700 Series or CS500 Series headset or MDA200.

ShoreTel models: IP 212K, 230, 265, 560, 560G, 560G, 655

Setup

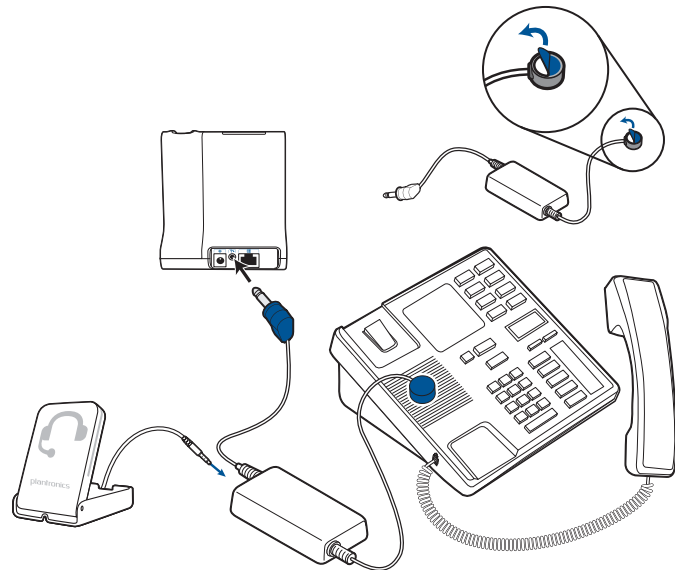

Configuration

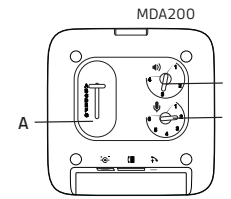
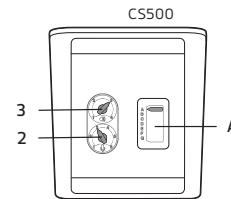
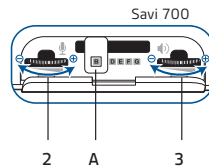

Electronic Hook Switch for Siemens®

SIEMENS



Desk Phone Models

Optipoint 410	OpenStage 40
Optipoint 420	OpenStage 60
Optipoint 500	OpenStage 80
Optipoint 600	



EHS Cable



APS-11*
PN: 37818-11

* APS-11 replaces APS-10



Plantronics Audio Solutions



Savi 700 Series

Wireless headset system manages PC, mobile and desk phone calls

CS500 Series

Wireless headsets manage desk phone calls

MDA200

Enables USB connectivity to the desk phone to manage both PC and desk phone calls

EHS Setup Use the EHS setup below to automatically answer a desk phone call by pressing a button on your Savi 700 Series or CS500 Series headset or MDA200.

Siemens models: Optipoint 410, 420, 500, 600

Setup

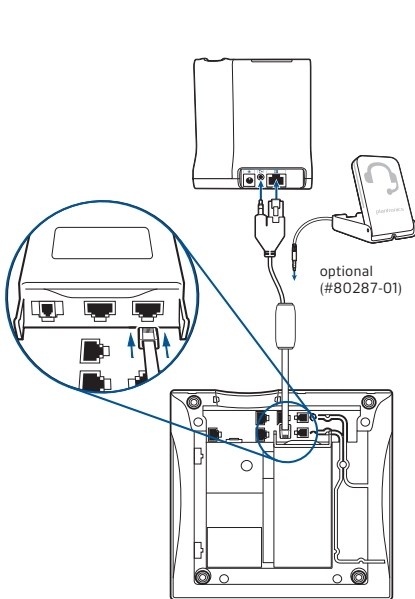

Configuration

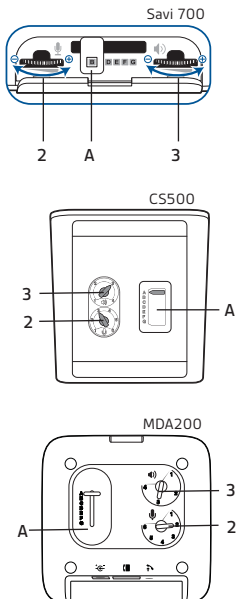

Siemens models: OpenStage 40, 60, 80

Setup

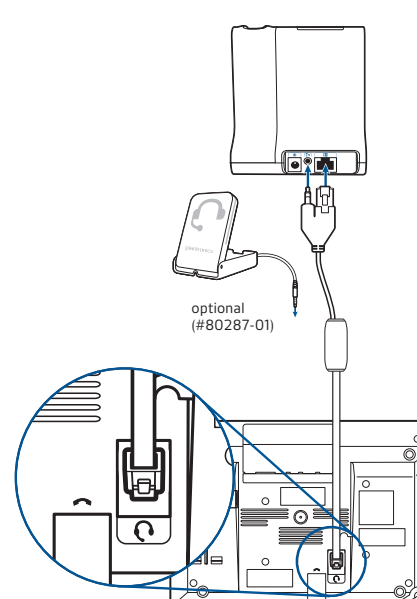

Configuration

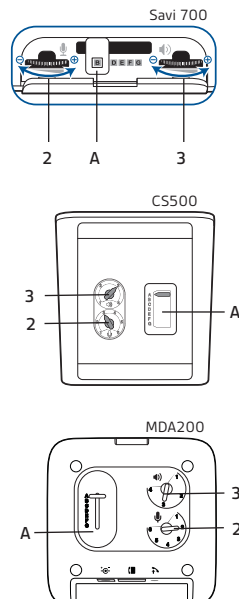

Electronic Hook Switch for Tenovis

TENOVIS

Desk Phone Models

- T3 Classic with Interface Adapter
- T3 IP Classic
- T3 IP II Classic
- T3 IP Classic with Interface Adapter
- TH13
- TM13
- TS13
- T3 Compact
- T3 IP Comfort
- T3 IP II Comfort
- OS 13
- OS33



+

EHS Cable



APT-31*
PN: 37820-11

* APT-31 replaces APT-30

+

Plantronics Audio Solutions



Savi 700 Series
Wireless headset system manages PC, mobile and desk phone calls

CS500 Series
Wireless headsets manage desk phone calls

MDA200
Enables USB connectivity to the desk phone to manage both PC and desk phone calls

EHS Setup Use the EHS setup below to automatically answer a desk phone call by pressing a button on your Savi 700 Series or CS500 Series headset or MDA200.

Tenovis models: T3 Classic with Interface Adapter, T3 IP Classic, T3 IP II Classic T3 Classic with Interface Adapter, TH13, TM13, TS13, T3 Compact, T3 IP Comfort, T3 IP II Comfort, OS 13, OS33

Setup

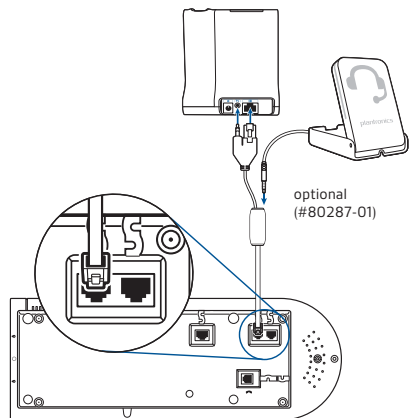

Configuration

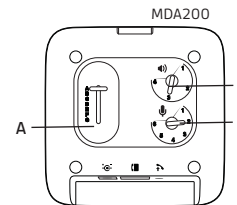
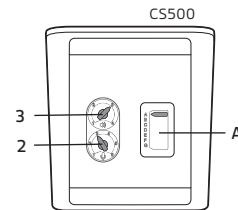
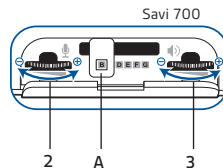

Electronic Hook Switch for Toshiba®

TOSHIBA



Desk Phone Models
 DP 5118-DP IPT 2008-SDL
 DP 5130-SDL IPT 2010-SD
 DP 5X22-SD IPT 2020-SD
 DP 5X32-SD

+

EHS Cable



RD-1
 PN: 78887-01

+

Plantronics Audio Solutions



Savi 700 Series
 Wireless headset system manages PC, mobile and desk phone calls

CS500 Series
 Wireless headsets manage desk phone calls

MDA200
 Enables USB connectivity to the desk phone to manage both PC and desk phone calls

EHS Setup Use the EHS setup below to automatically answer a desk phone call by pressing a button on your Savi 700 Series or CS500 Series headset or MDA200.

Toshiba models: DP 051180-DP, DP 5130-SDL, DP 5X22-SD, DP-5X32, IPT 2008-SDL, IPT 2010-SDL, IPT 2020-SD

Setup

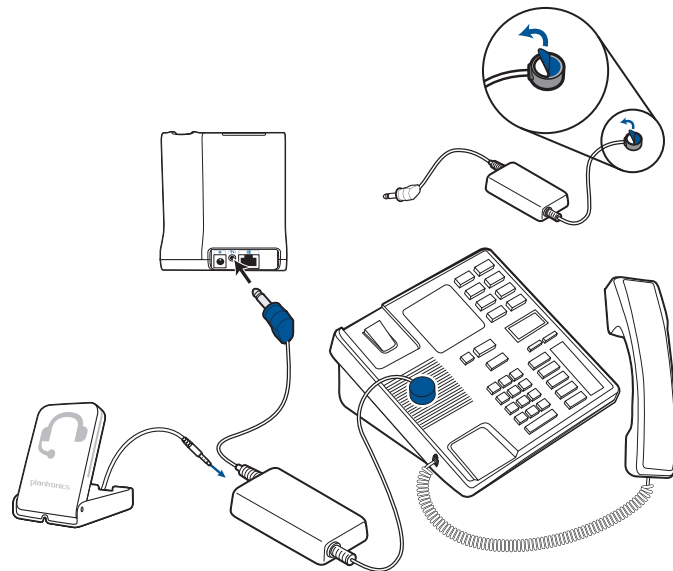

Configuration

